

1- Relaciona cada pieza con sus vistas

						
ALZADO						
PLANTA						
PERFIL						

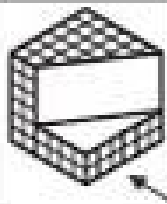

1

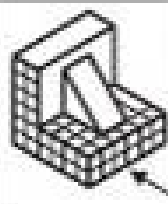
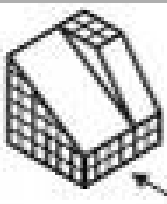
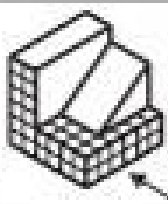
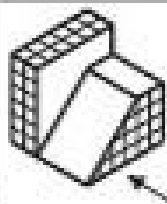
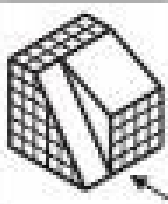
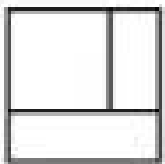
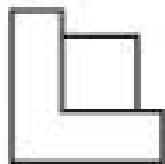

2

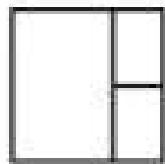

3

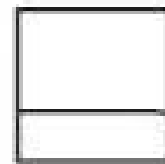

4

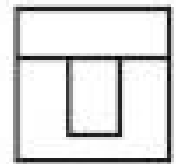

5

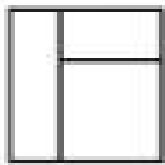

6

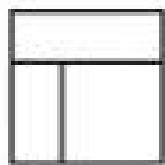

7

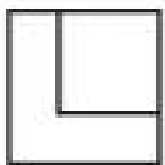

8

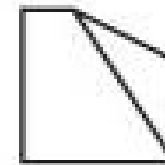

9

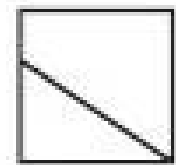

10



11

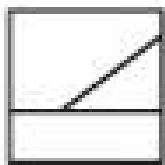

12

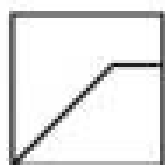

13

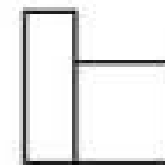

14

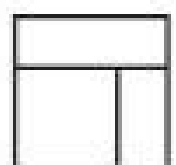

15

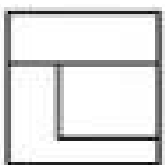

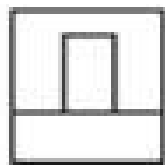

16

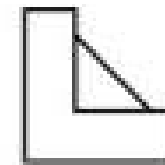

17

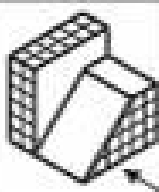
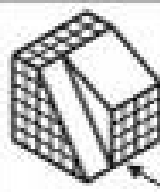
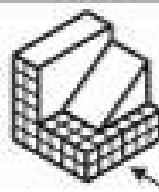
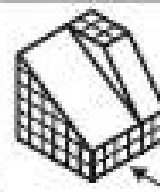
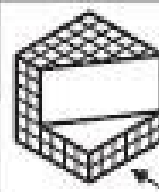

18

						
ALZADO						
PLANTA						
PERFIL						

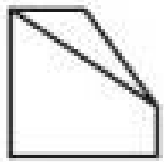

1

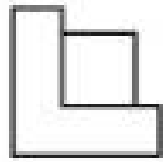

2

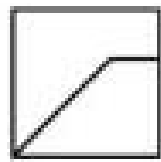

3

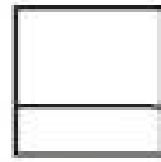

4

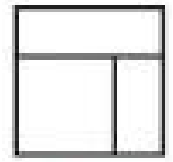

5

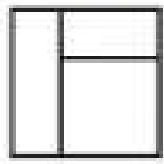

6

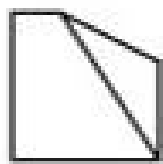

7

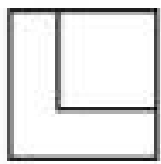

8

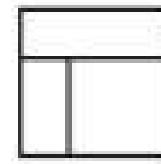

9

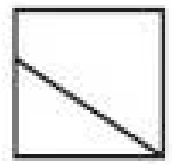

10

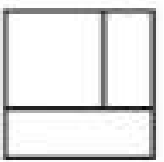

11

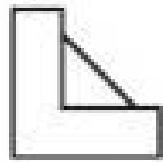

12

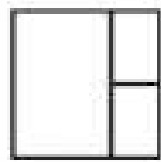

13

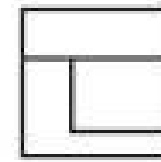

14

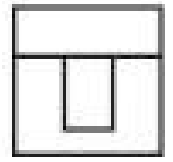

15

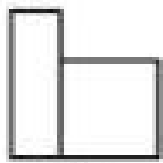

16

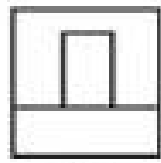

17

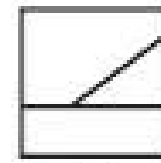

18

2- Indica las vistas de estas piezas

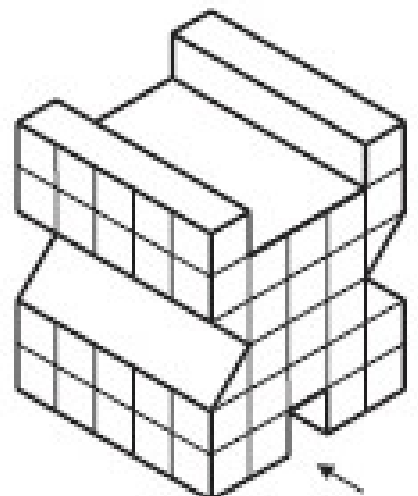
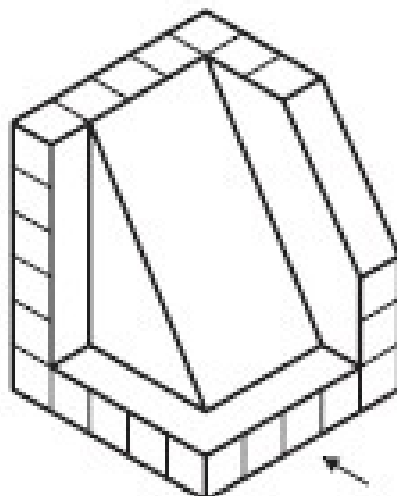
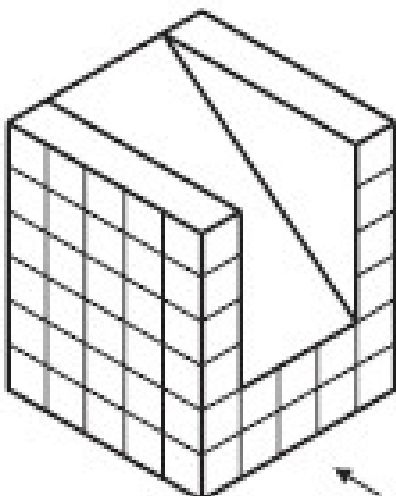
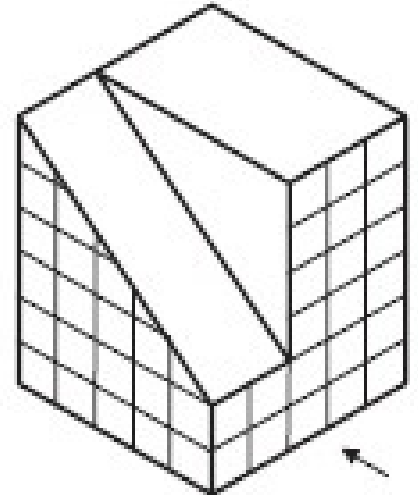
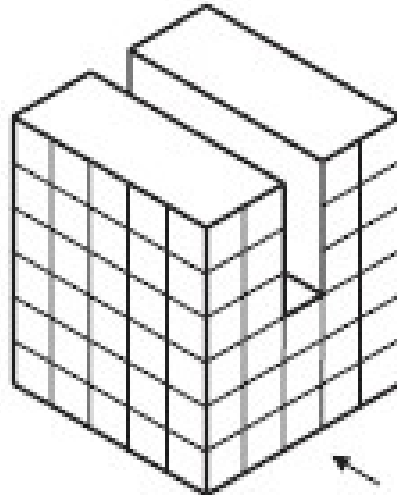
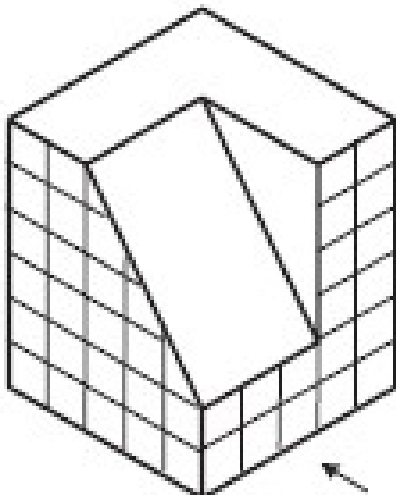
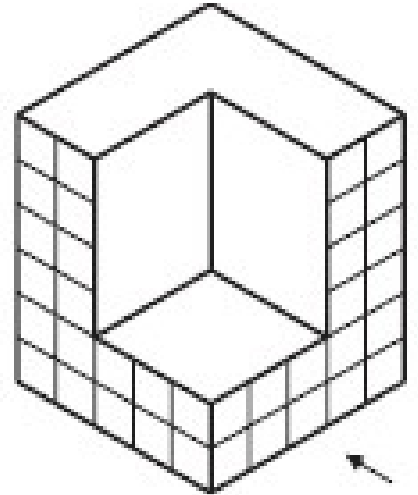
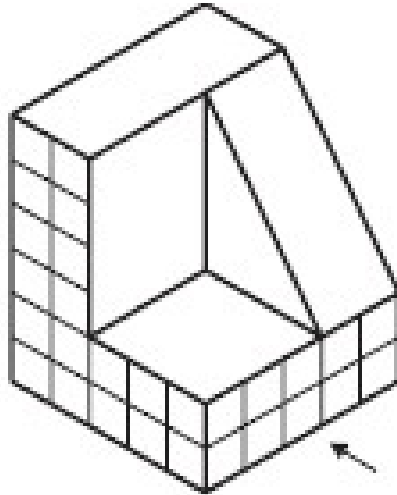
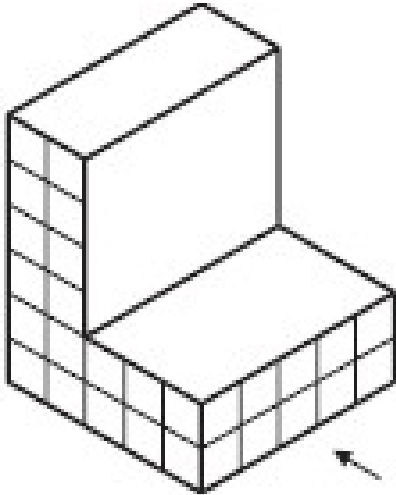

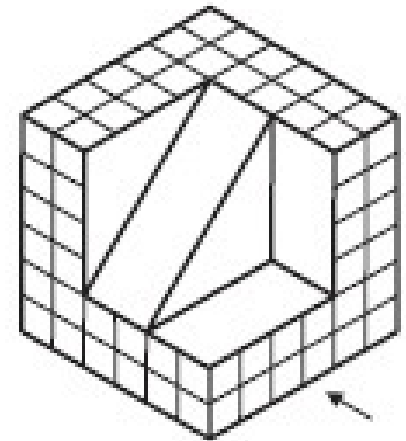
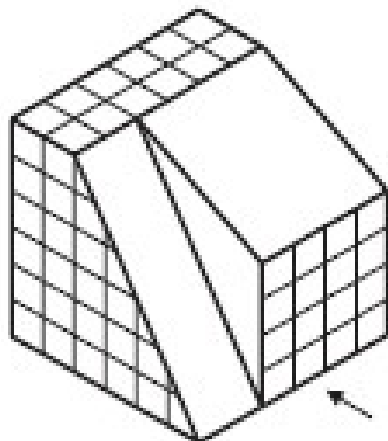
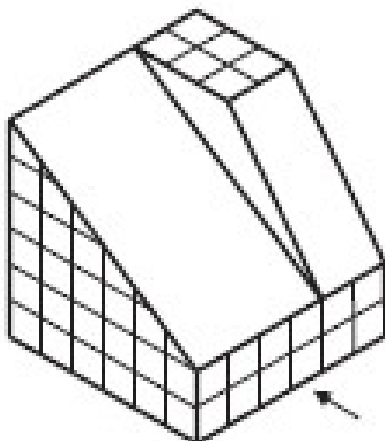
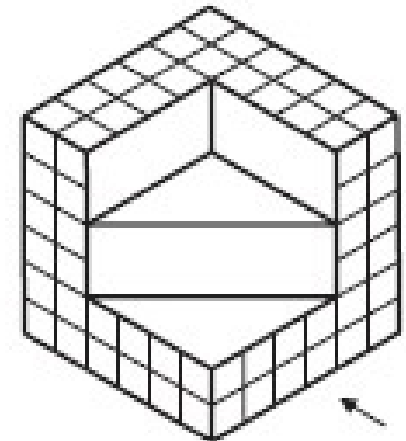
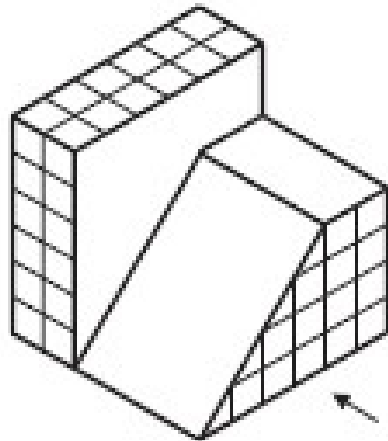
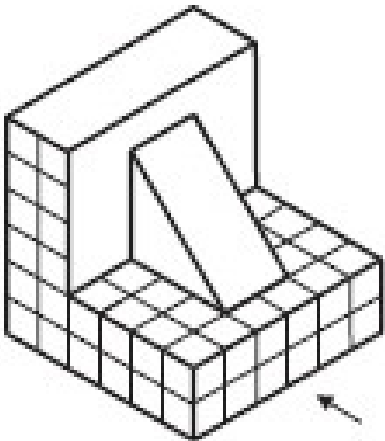
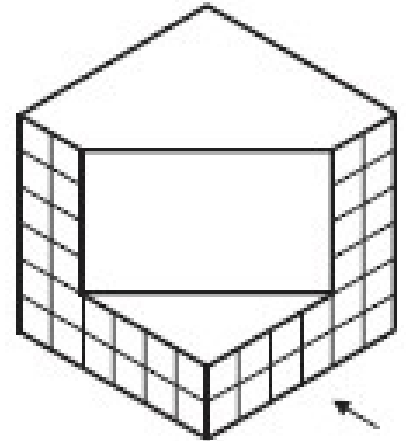
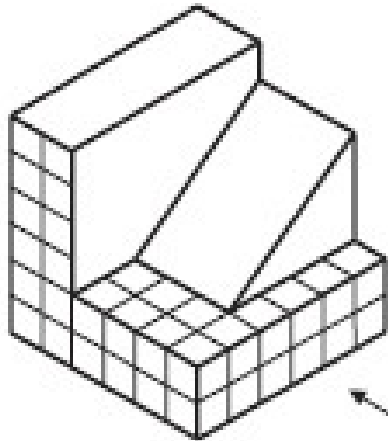
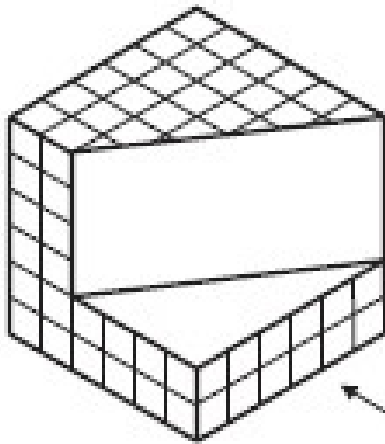

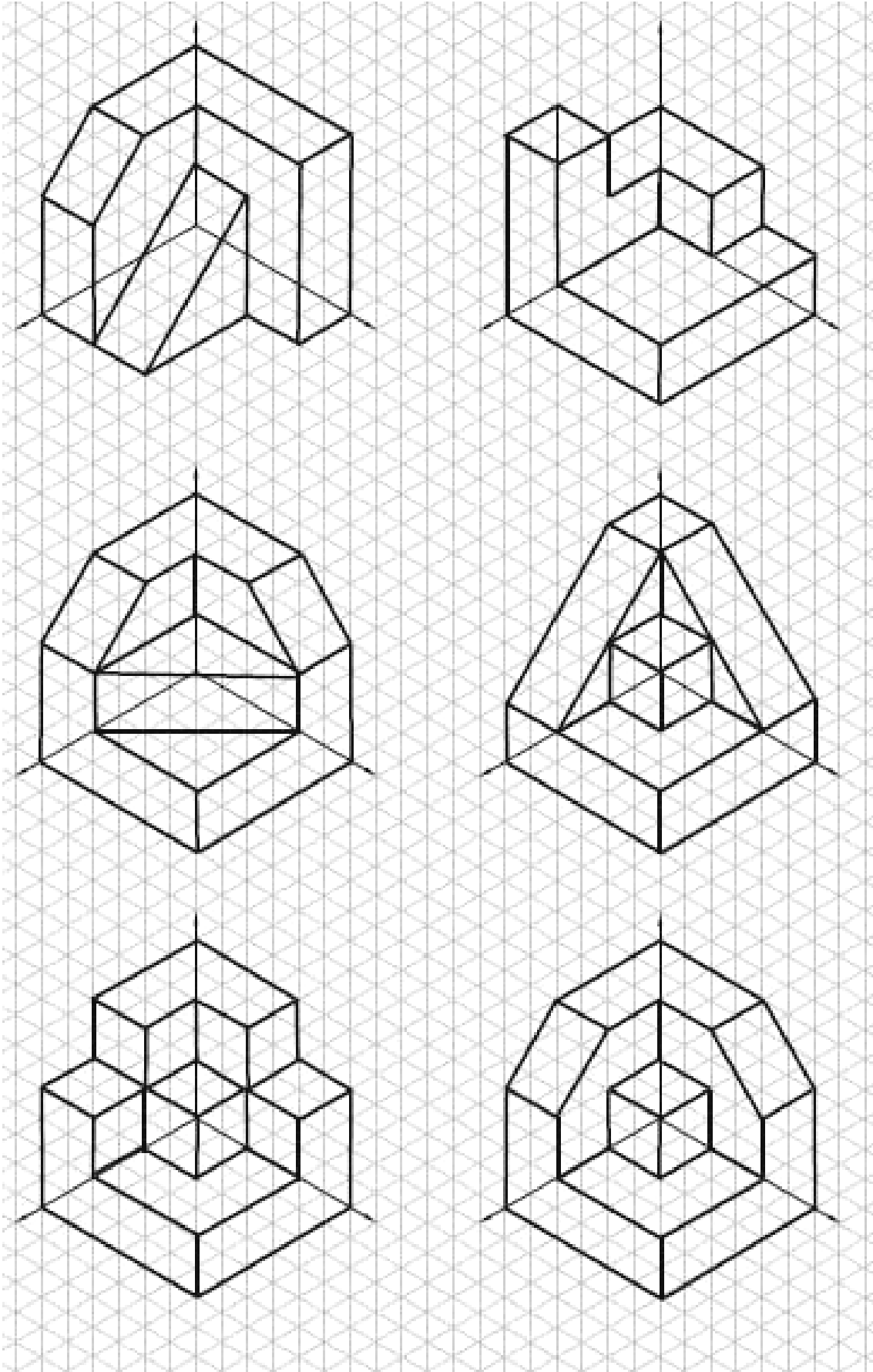

3- Dadas las vistas, dibuja en perspectiva isométrica la pieza. (Solución página 5)

